



Молдинги



М-35-20-1000



Внешний угол

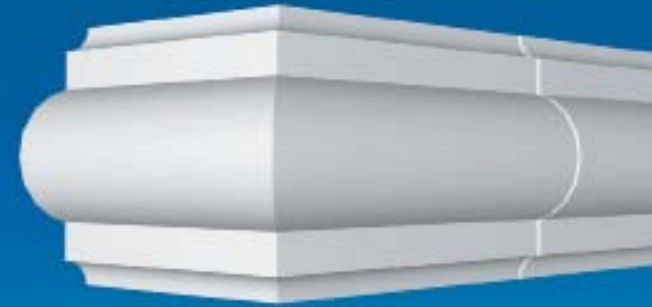

Внутренний угол

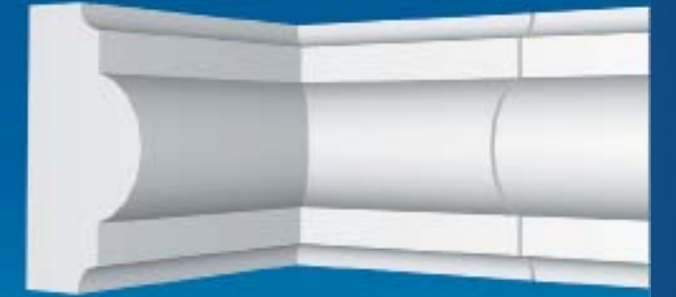

Сечение





М-50-20-1000

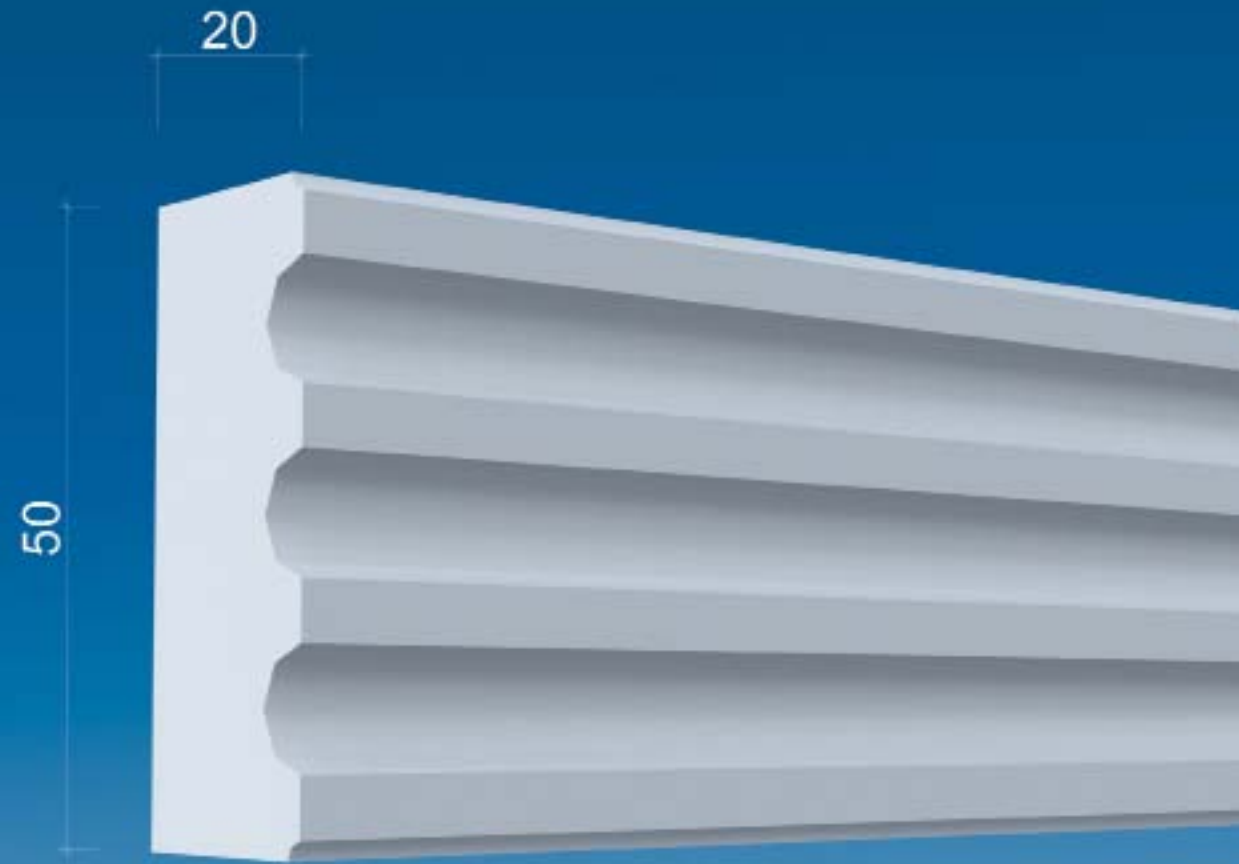

140

Внешний угол



141

Внутренний угол



Сечение



М-55-25-1000

ЛУЧШИЙ ВЫБОР



Внешний угол



Внутренний угол



Сечение





М-70-50-1000



144

Внешний угол



145

Внутренний угол



Сечение

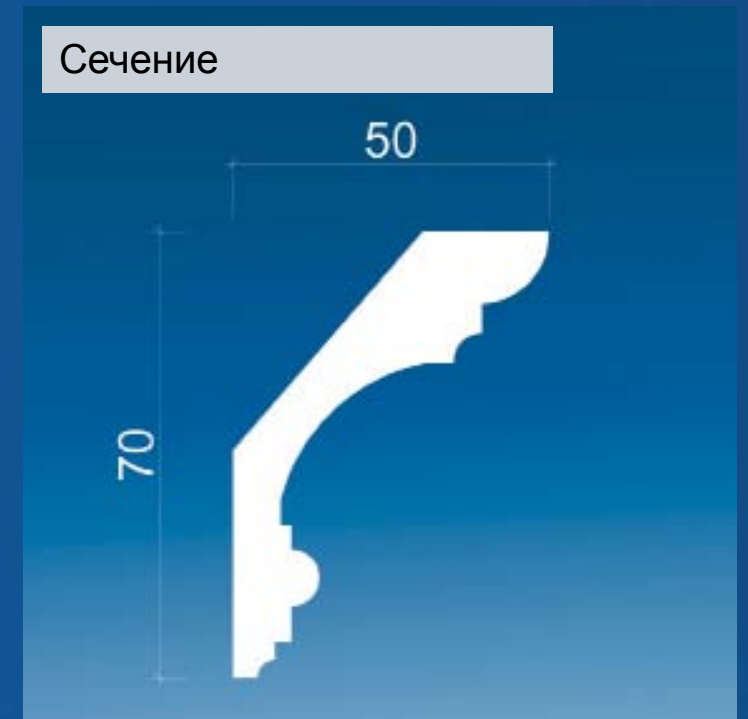

М-90-90-1000

ЛУЧШИЙ ВЫБОР

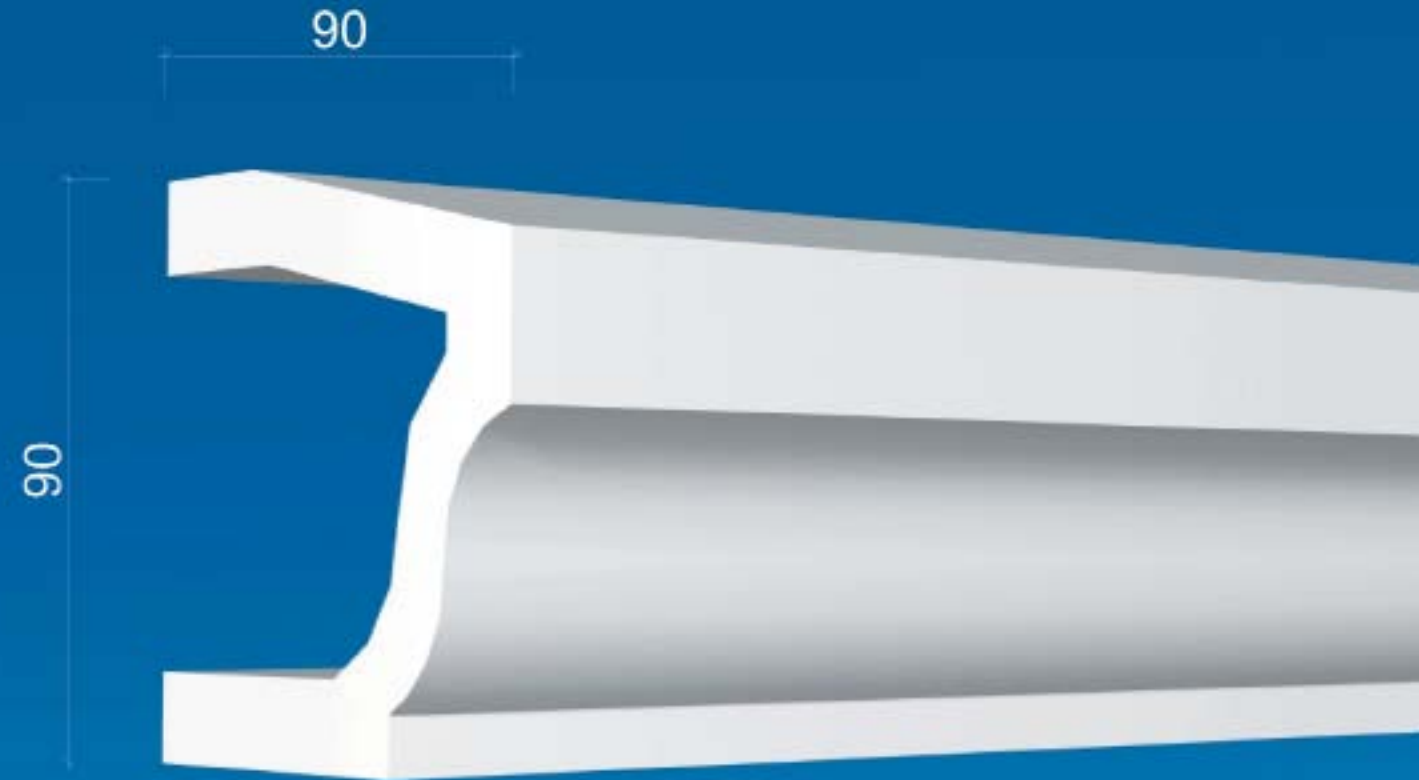

Внешний угол



Внутренний угол

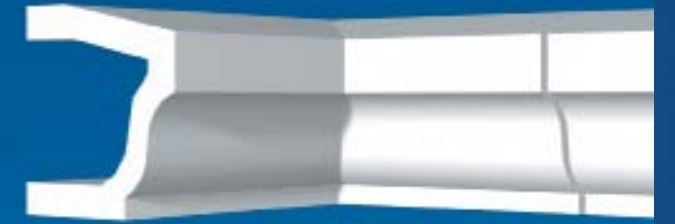

Сечение

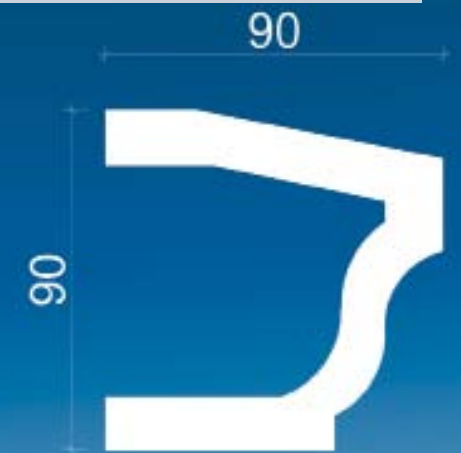



М-100-50-1000

ЛУЧШИЙ ВЫБОР

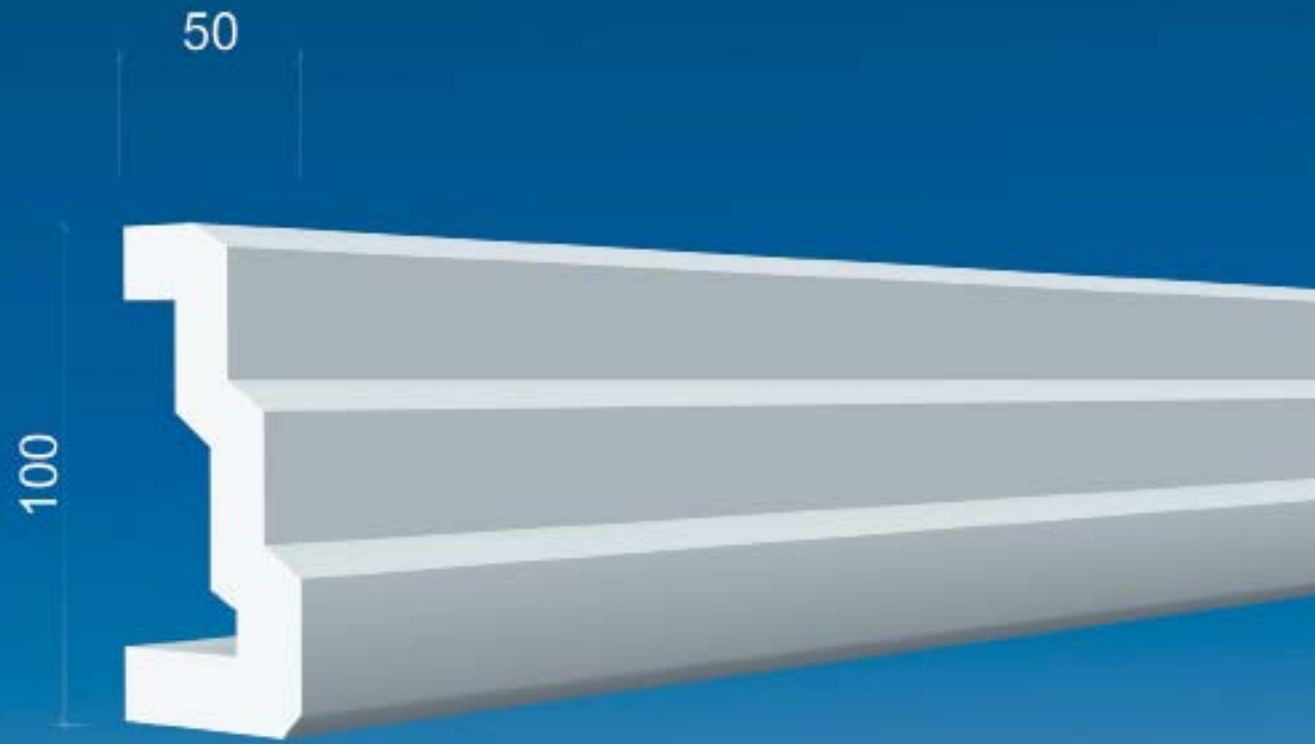

Внешний угол



Внутренний угол

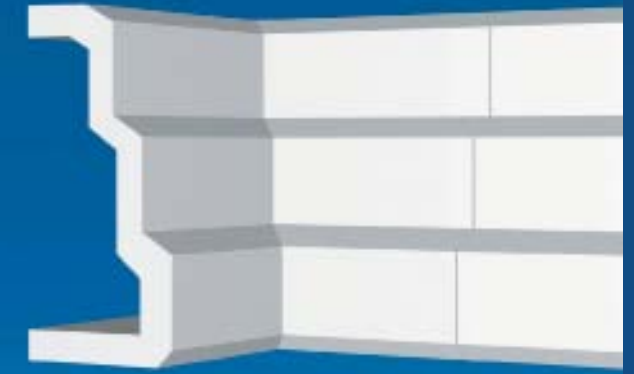

Сечение





М-105-50-1000

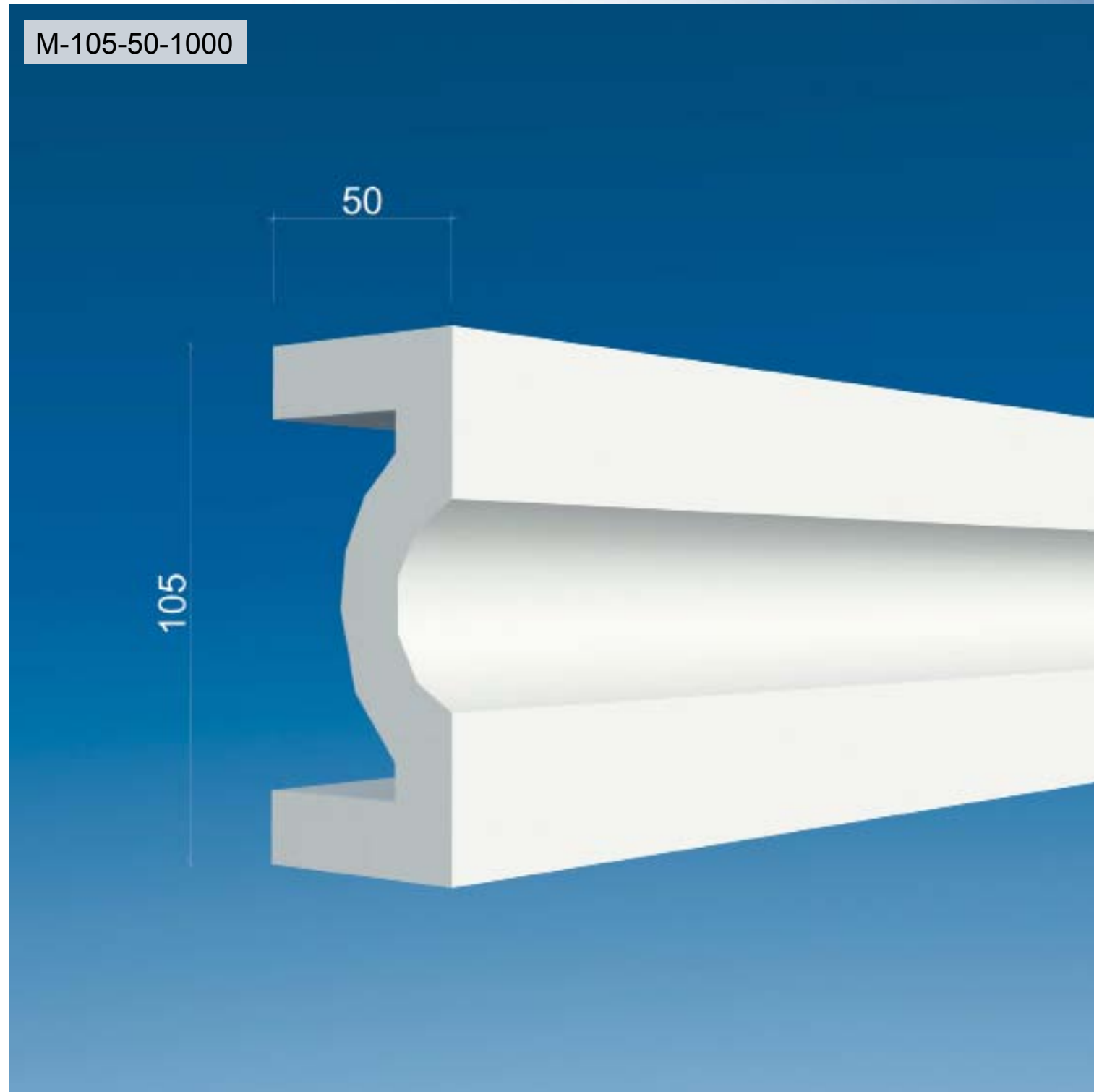

150

Внешний угол

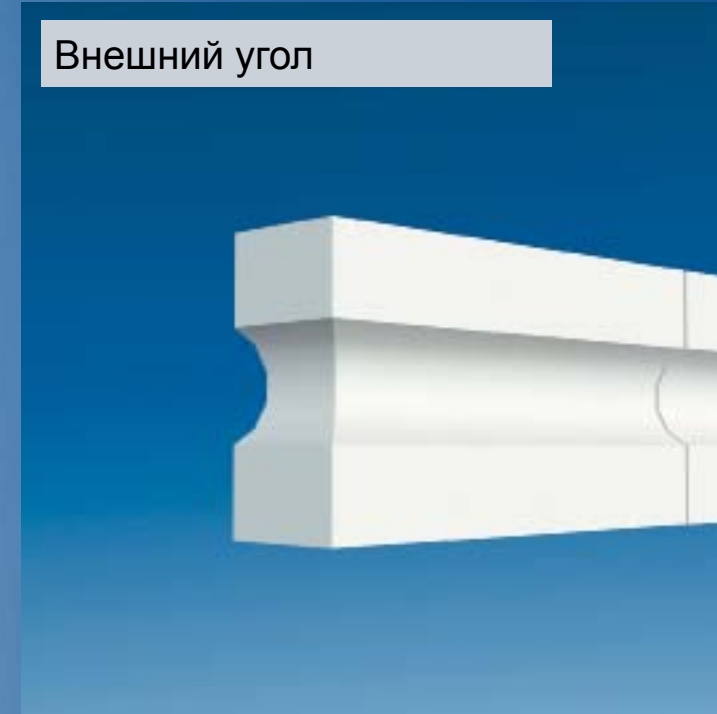

151

Внутренний угол



Сечение

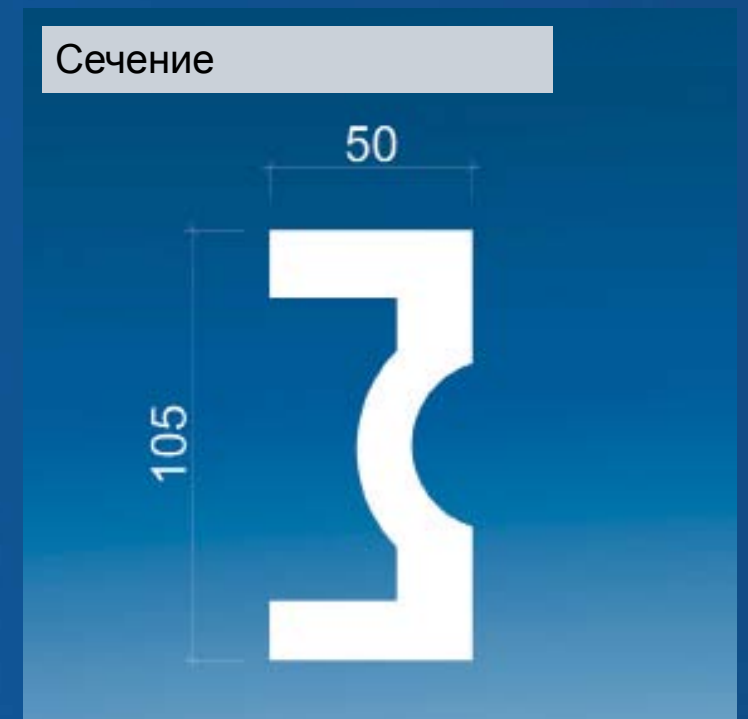



М- 110-55-1000



152

Внешний угол

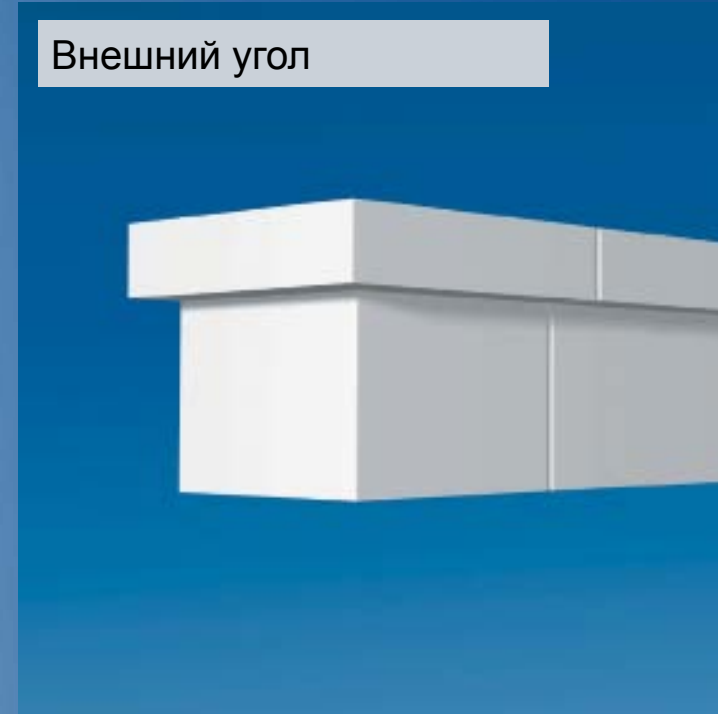

153

Внутренний угол



Сечение

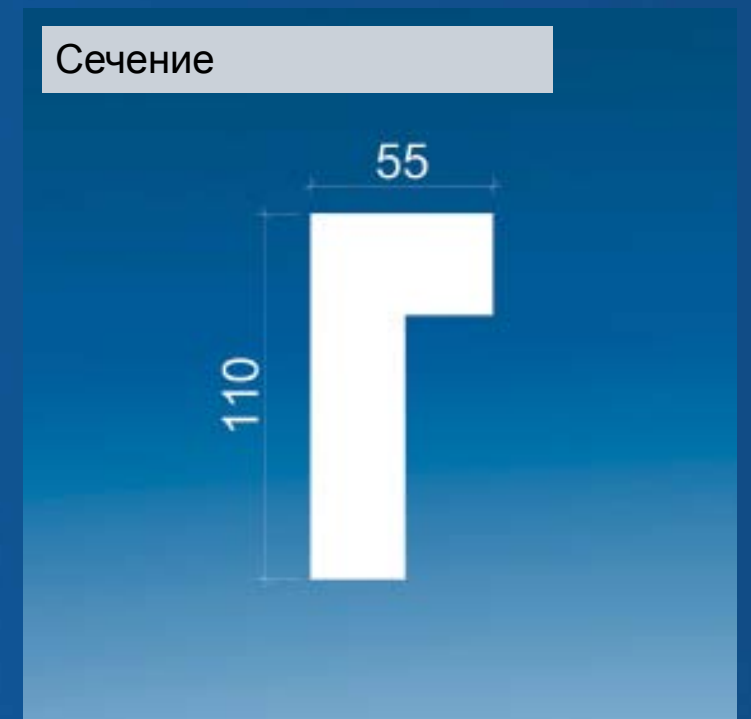



М-120-120-1000

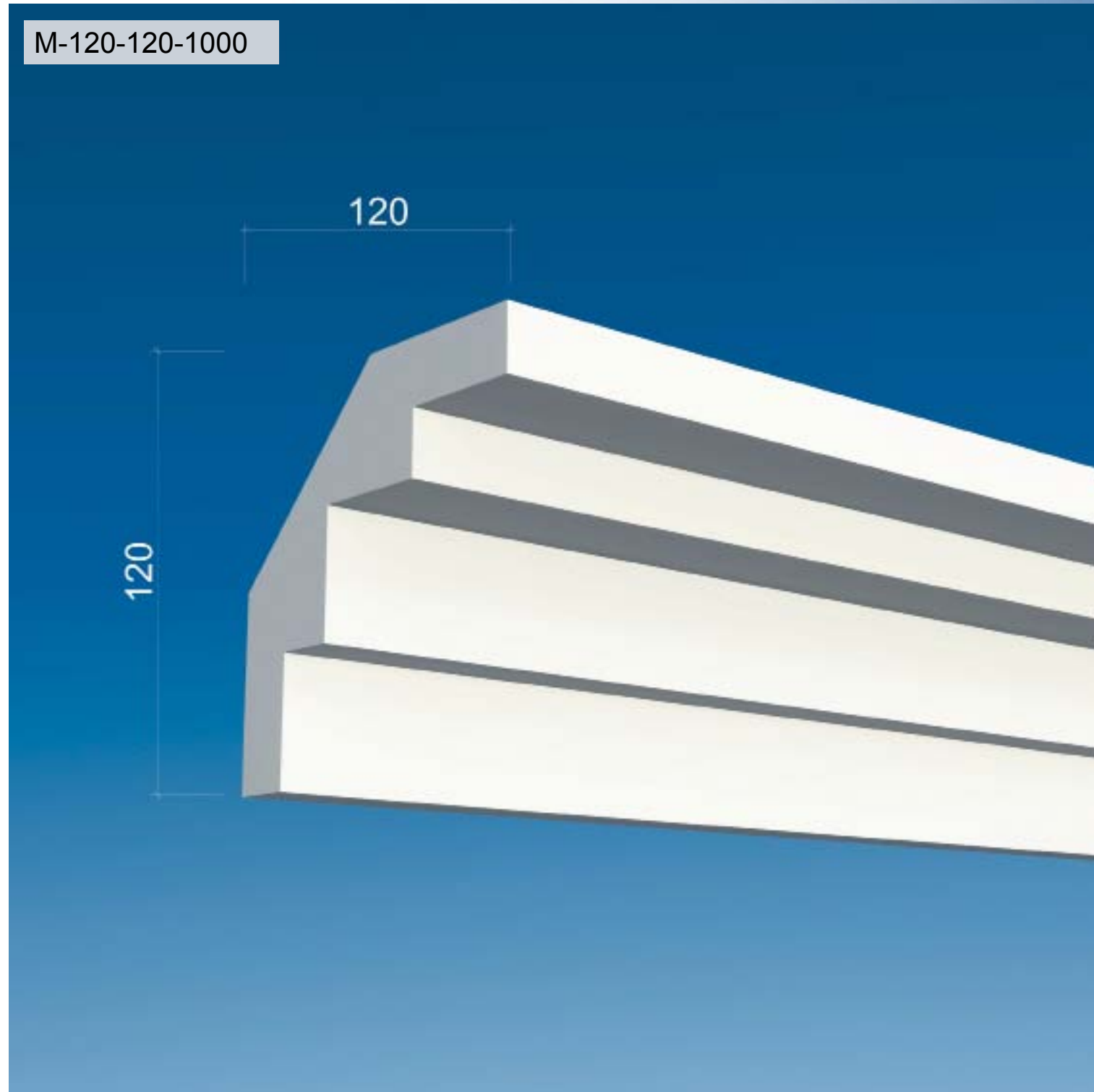

Внешний угол



Внутренний угол



Сечение

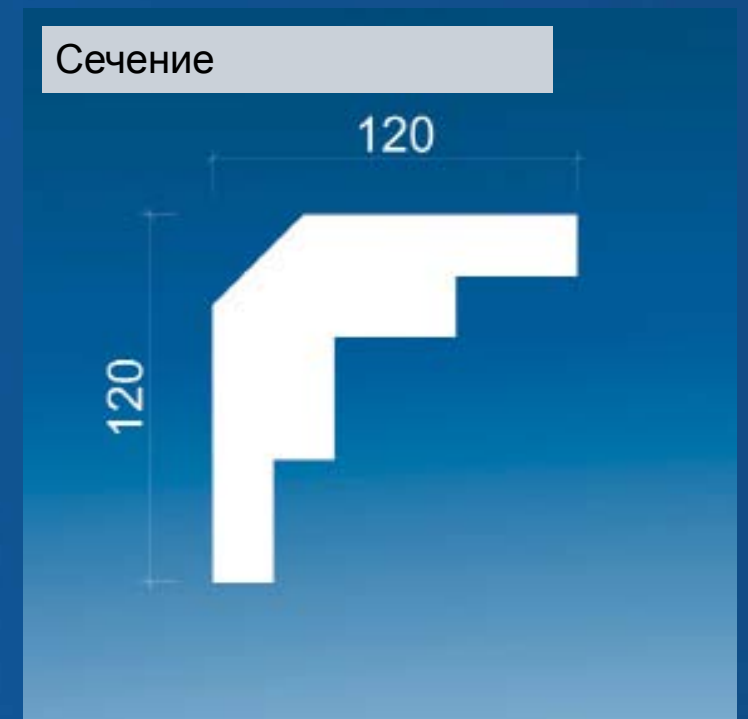



М-150-50-1000



156

Внешний угол

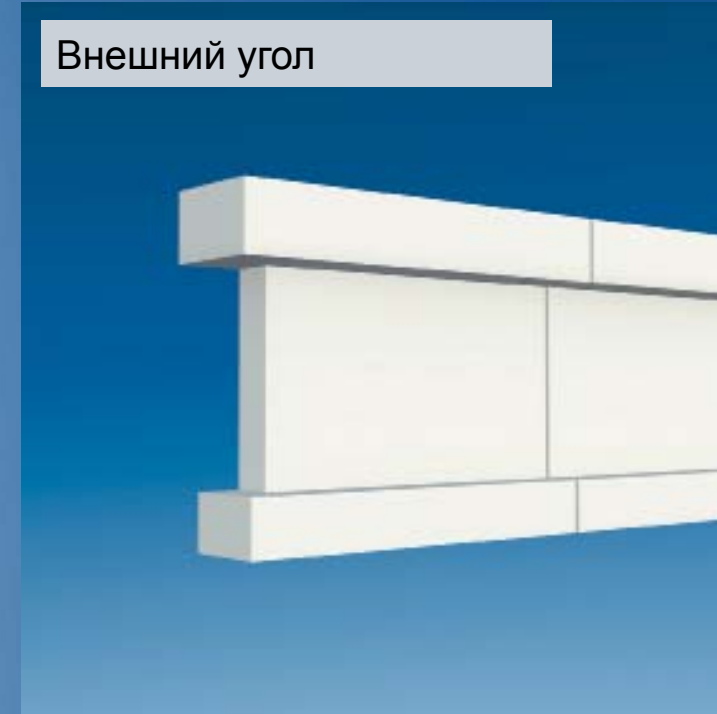

157

Внутренний угол



Сечение





М-150-130-1000



158

Внешний угол



159

Внутренний угол



Сечение

